

VILPE®
Innovative and Easy

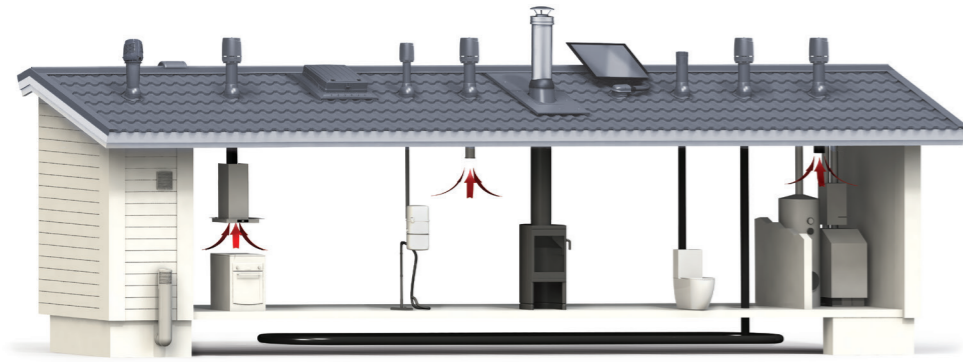

EXHAUST VENTS



The VILPE product family includes a complete selection of roof elements and terminal equipment for ventilation. VILPE products form ensembles easy to assemble since all the installation tools and instructions are included in the sets. Uniquely long warranties only apply to ensembles with genuine VILPE products.

P-series for pitched roofs

The P-series roof fans and exhaust ventilation pipes can be led watertightly with a pass-through set through a roof. VILPE pass-through sets can be installed on any roofs with the most common pitches. The pass-through set is always selected according to the roofing material of the roof. All the roof fans and exhaust ventilation pipes in the P-series are compatible with all pass-through set types. Using P-series XL roof fans and XL exhaust ventilation pipes requires an XL pass-through.



S-series for flat surface installation

The S-series roof fans and exhaust vents are designed to be installed in the ventilation shaft, onto a silencer or in or other horizontal surface. Thus, they are also suitable for gently sloping roofs. The S-roof fans and S-exhaust vents are used, for example, in blocks of flats and terraced houses, when flat-specific ventilation is required. The S-series roof fan can also be used for modifying an old natural ventilation system into a mechanical one during renovation.



VILPE® - maximal roof pitches for P-series pass-throughs

Pass-through	Pipe XL Pass-through	Ø 110 mm	Ø 125 mm	Ø 160 mm	Ø 160 mm XL	Ø 200 mm XL	Ø 250 mm XL
Tile 2K / Tiili	XL Tile	40° / 48°	37° / 48°	32° / 37°	47°	45°	43°
Unitile 2K / Unitile	-	48° / 57°	46° / 57°	43° / 52°	-	-	-
Vitlinge 1-w	-	45°	40°	30°	-	-	-
Vitlinge 2-w	-	55°	50°	35°	-	-	-
Profiled steel 2K / Profiled steel	XL Universal MK1	43° / 50°	40° / 45°	36° / 40°	47°	47°	47°
Steel	XL Universal	45°	40°	27°	47°	47°	47°
Classic	XL Classic	55°	55°	48°	47°	47°	47°
Classic Vino 2K	-	48°	46°	43°	-	-	-
HS Slate	-	59°	57°	52°	-	-	-
Felt	XL Felt	50°	50°	45°	47°	48°	45°
Felt Tall	XL Felt Tall	*	*	*	*	*	*
Decra	-	45°	45°	45°	-	-	-
Eternit B9	-	45°	45°	45°	-	-	-
Nera	-	57°	57°	50°	-	-	-
Evo 2K	-	39°	38°	30°	-	-	-
Aalto 2K	-	55°	50°	45°	-	-	-

P-series pass-throughs are for roofs with pitches of more than 1:5 (11.5°), unless stated otherwise.

On maximal roof pitches make sure that the roof structure does not prevent the installation.

* The Felt pass-through tall is designed for installation on roofs with a pitch of less than 1:5 (11.5°). For the steeper roofs the normal Felt pass-through suits better.

Note! The roof pitches in the table are suggestive values. In extreme situations, the height of the roofing profile or the installation point of the underlay seals affects the values.

Reference colour	Colour	RAL
	Black	RAL 9017
	Brown	RAL 8017
	Green	RAL 6020
	Grey	RAL 7015
	Red	RAL 3009
	Brick Red	RAL 8004
	Light Grey	RAL 7040
	Silver-grey	RAL 7001

125P/IS/500 FLOW EXHAUST VENTILATION PIPE

Description: Insulated exhaust ventilation pipe with the FLOW-cowl. Includes a galvanized steel inner pipe with a lip seal. A VILPE® pass-through chosen according to roof type and material sold separately.
Contents: Exhaust ventilation pipe, FLOW-cowl, screws.

Colour	Product No
Black	350042
Brown	350044
Green	350046
Grey	350047
Red	350048
Brick Red	350049
Light Grey	350041
Anthracite	35004G

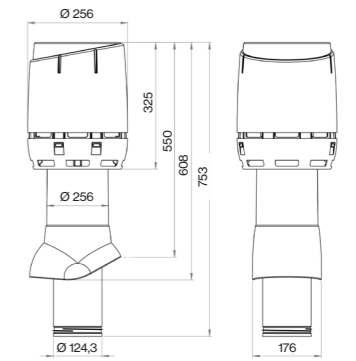

125S 250X250 FLOW EXHAUST VENT

Description: Exhaust vent for a flat surface with the FLOW-cowl.
Contents: Exhaust vent, installation set, adapter and screws.

Colour	Product No
Black	350012
Brown	350014
Green	350016
Grey	350017
Red	350018
Brick Red	350019
Light Grey	350011

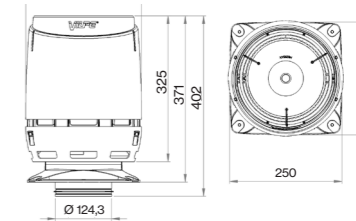

160P/IS/500 FLOW EXHAUST VENTILATION PIPE

Description: Insulated exhaust ventilation pipe with the FLOW-cowl. Includes a galvanized steel inner pipe with a lip seal. A VILPE® pass-through chosen according to roof type and material sold separately.
Contents: Exhaust ventilation pipe, FLOW-cowl, screws.

Colour	Product No
Black	350052
Brown	350054
Green	350056
Grey	350057
Red	350058
Brick Red	350059
Light Grey	350051
Anthracite	35005G

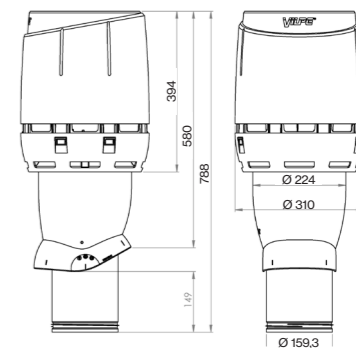

160S 300X300 FLOW EXHAUST VENT

Description: Exhaust vent for a flat surface with the FLOW-cowl.
Contents: Exhaust vent, installation set, adapter and screws.

Colour	Product No
Black	350032
Brown	350034
Green	350036
Grey	350037
Red	350038
Brick Red	350039
Light Grey	350031

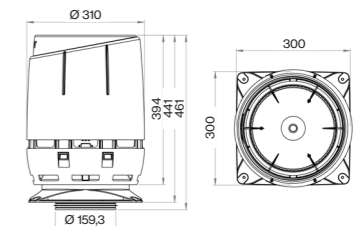

160P/IS/500 FLOW XL EXHAUST VENTILATION PIPE

Description: Insulated exhaust ventilation XL pipe with the FLOW-cowl. Includes a galvanized steel inner pipe with a lip seal. A VILPE® XL passthrough chosen according to roof type and material sold separately.
Contents: Exhaust ventilation pipe, FLOW-cowl, screws.

Colour	Product No
Black	350102
Brown	350104
Grey	350107
Red	350108
Brick Red	350109

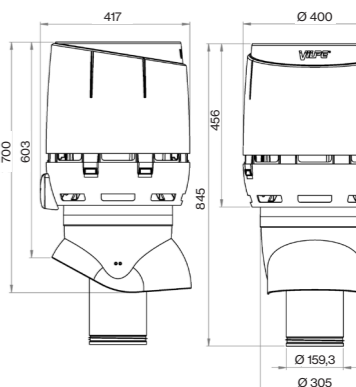

Ø200 FLOW XL Exhaust vents

Colour Product No

200P/IS/500 FLOW EXHAUST VENTILATION PIPE

Description: Insulated exhaust ventilation XL pipe with the FLOW-cowl. Includes a galvanized steel inner pipe with a lip seal. A VILPE® XL pass-through chosen according to roof type and material sold separately.
Contents: Exhaust ventilation pipe, FLOW-cowl, screws.

Black	350132
Brown	350134
Grey	350137
Red	350138
Brick Red	350139

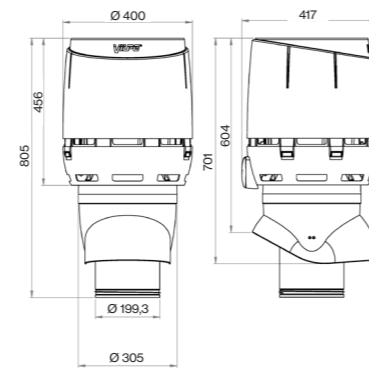

200S 400X400 FLOW EXHAUST VENT

Description: Exhaust vent for a flat surface with the Flow-cowl.
Contents: Exhaust vent, installation set, adapter and screws.

Black	350162
Brown	350164
Grey	350167
Red	350168
Brick Red	350169

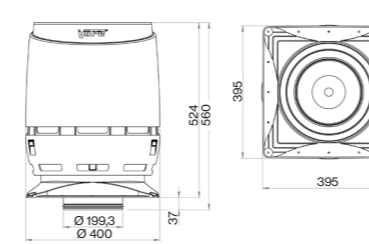

Ø250 FLOW XL Exhaust vents

Colour Product No

250P/IS/500 FLOW EXHAUST VENTILATION PIPE

Description: Insulated exhaust ventilation XL pipe with the FLOW-cowl. Includes a galvanized steel inner pipe with a lip seal. A VILPE® XL pass-through chosen according to roof type and material sold separately.
Contents: Exhaust ventilation pipe, FLOW-cowl, screws.

Black	350152
Brown	350154
Grey	350157
Red	350158
Brick Red	350159

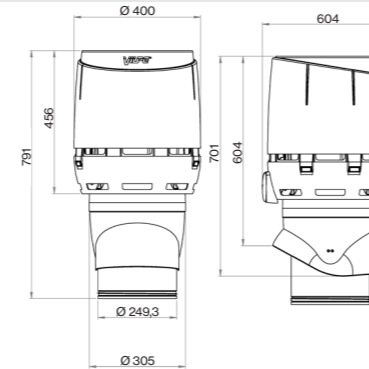

250S 400X400 FLOW EXHAUST VENT

Description: Exhaust vent for a flat surface with the Flow-cowl.
Contents: Exhaust vent, installation set, adapter and screws.

Black	350172
Brown	350174
Grey	350177
Red	350178
Brick Red	350179

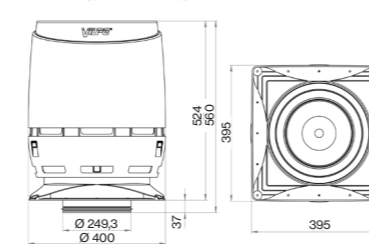

Performance of FLOW exhaust vents

Performance of our whole VILPE FLOW exhaust vent range, with the pipe size in blue. Part of the data is extrapolated.

Recommended range in green.

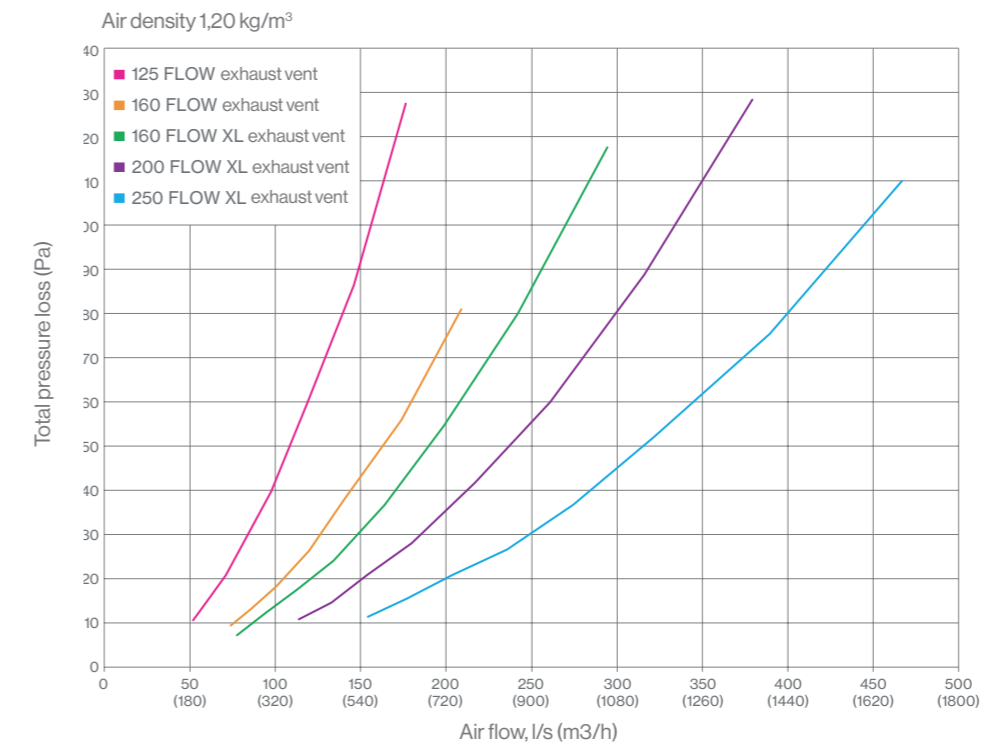
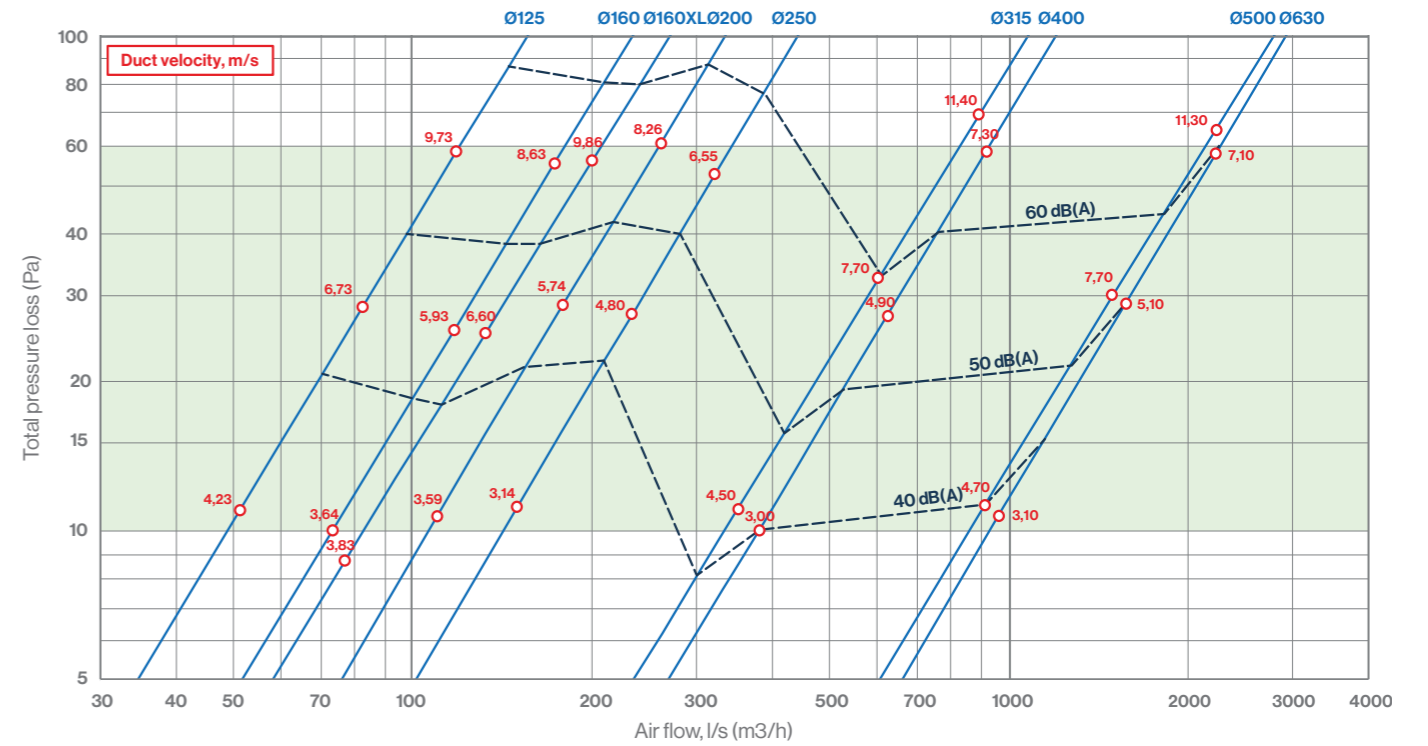





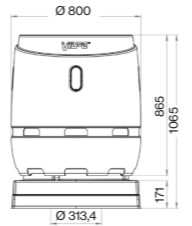
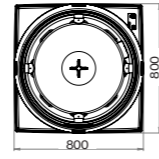

Noise level correction

Distance (m)	Noise level distance correction (dB(A))
5	-22
10	-28
15	-32
20	-34
30	-38
40	-40
50	-42
60	-44
80	-46
100	-48
120	-50
140	-51
160	-52

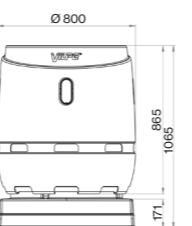
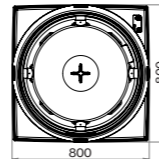

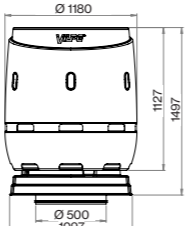
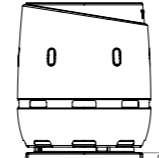
315-630S Exhaust vents

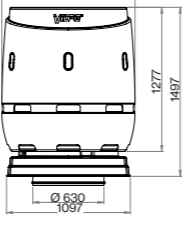
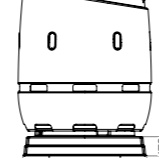
	Colour	Product No			
VILPE 315S FLOW EXHAUST VENT + INSTALLATION SET Description: Exhaust vent with a FLOW cowl. Installed on a square-shaped 724x724 mm pass-through. An assembled square-shaped VILPE pass-through with a silencer will be added to the VILPE product selection during 2020. Content: Exhaust vent, Installation set, Ø 315 mm galvanized steel connection pipe.	Black	350402			
	Grey	350407			
	Silver-grey	350401			
VILPE 400S FLOW EXHAUST VENT + INSTALLATION SET Description: Exhaust vent with a FLOW cowl. Installed on a square-shaped 724x724 mm pass-through. An assembled square-shaped VILPE pass-through with a silencer will be added to the VILPE product selection during 2020. Content: Exhaust vent, Installation set, Ø 400 mm galvanized steel connection pipe.	Black	350412			
	Grey	350417			
	Silver-grey	350411			
VILPE 500S FLOW EXHAUST VENT + INSTALLATION SET Description: Exhaust vent with a FLOW cowl. Installed on a square-shaped 970x970 mm pass-through. An assembled square-shaped VILPE pass-through with a silencer will be added to the VILPE product selection during 2020. Content: Exhaust vent, Installation set, Ø 500 mm galvanized steel connection pipe.	Black	350432			
	Grey	350437			
	Silver-grey	350431			
VILPE 630S FLOW EXHAUST VENT + INSTALLATION SET Description: Exhaust vent with a FLOW cowl. Installed on a square-shaped 970x970 mm pass-through. An assembled square-shaped VILPE pass-through with a silencer will be added to the VILPE product selection during 2020. Content: Exhaust vent, Installation set, Ø 630 mm galvanized steel connection pipe.	Black	350442			
	Grey	350447			
	Silver-grey	350441			

Pass-throughs with a built-in silencer

	Dimensions (mm)			Weight (kg)	Product No	
	A	B*	C			
VILPE 315S FLOW PASS-THROUGH	724	800	Ø 316	53	350421	* VILPE 315-630S FLOW pass-throughs are also available in customised height options. Our sales team is happy to provide more details.
VILPE 400S FLOW PASS-THROUGH	724	800	Ø 401	53	350420	
VILPE 500S FLOW PASS-THROUGH	970	801	Ø 501	80	350450	
VILPE 630S FLOW PASS-THROUGH	970	801	Ø 631	77	350451	
VILPE 315/400 FLOW STEEL FLASHING SET FOR PASS-THROUGH	720	400		5,9	350423	
VILPE 500/630 FLOW STEEL FLASHING SET FOR PASS-THROUGH	966	400		7,7	350453	

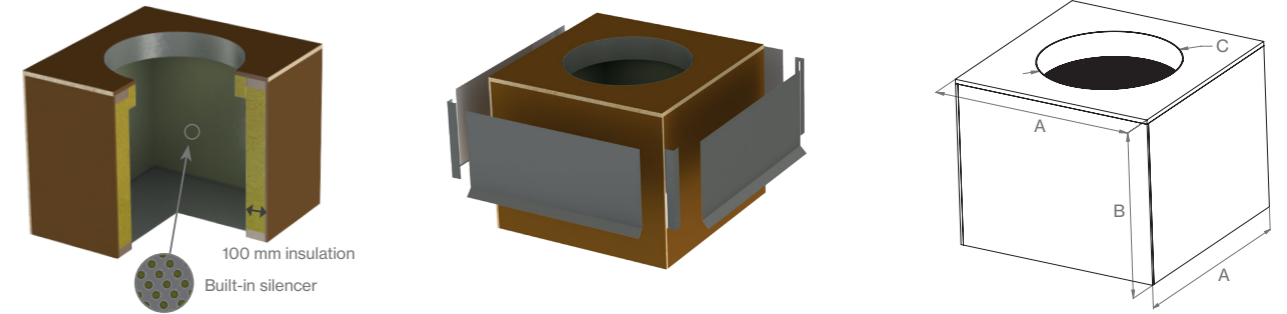

Installation on pitched roofs

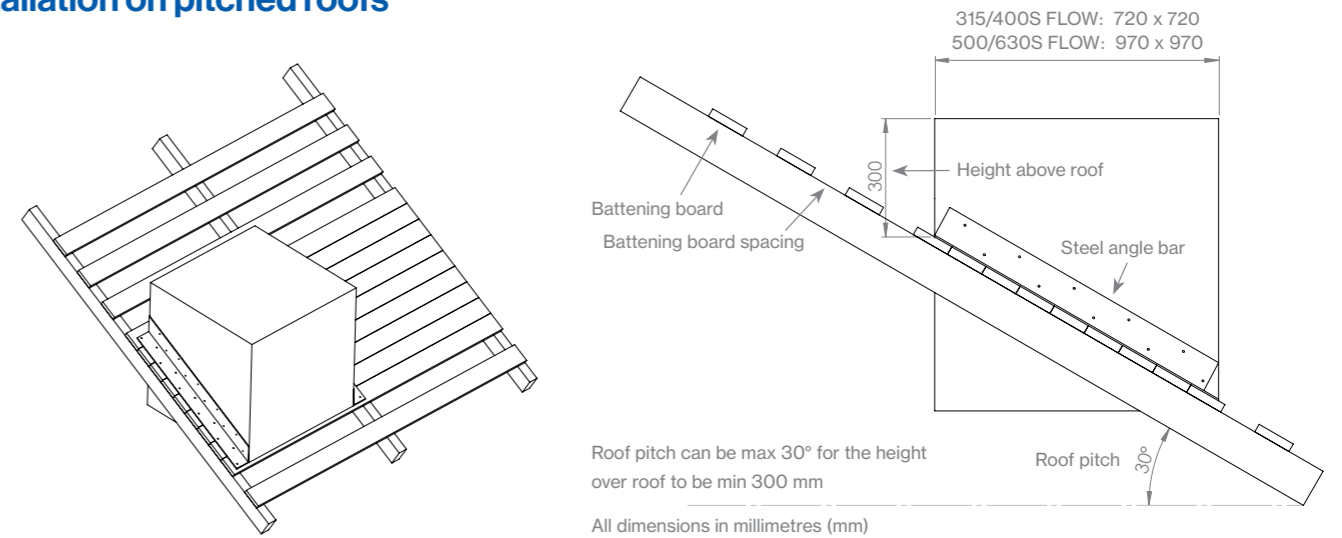

Installation on flat roofs

The VILPE 315-630S FLOW pass-throughs and exhaust vents are installed on flat roofs using steel angle brackets.

*Steel angle brackets are not included in package.

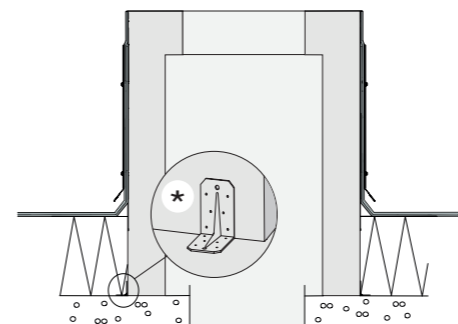

More information about installation on flat roofs can be found in the installation manual, which is included in the product package.

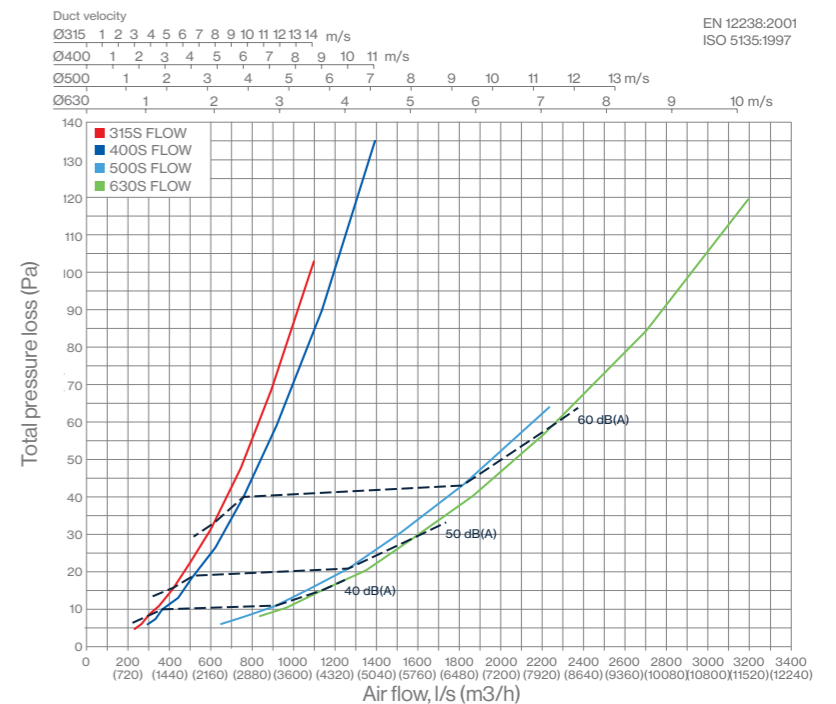
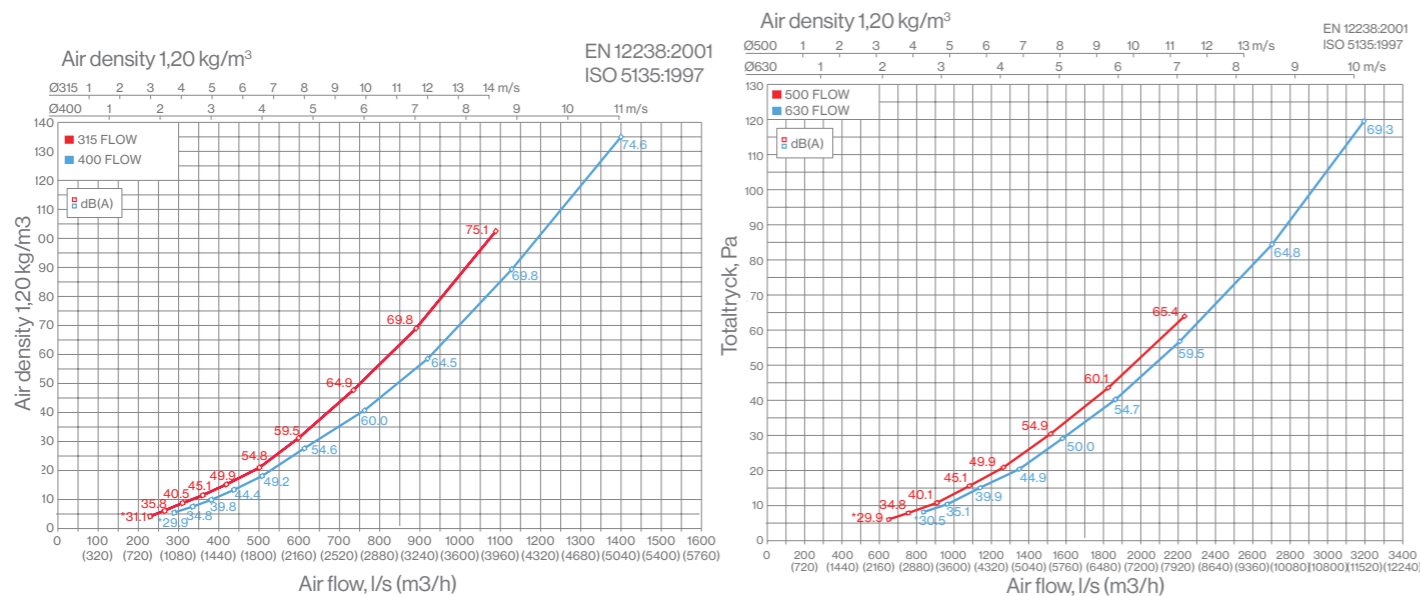



Guaranteed excellent quality

The VILPE products create better indoor air, improve energy efficiency and prolong the lifetime of buildings. The products are manufactured by a Finnish family business VILPE which is the leading manufacturer and developer of ventilation and special roofing products in Finland, Baltics, Russia and Scandinavia.

The products are of excellent quality and are durable, which is why we offer a 20-year warranty of technical parts and 10-year colour warranty. The management system of VILPE Oy has been granted both the ISO 9001:2015 quality certificate the ISO 14001:2015 environmental certificate. These certificates cover product development, manufacturing and sales of VILPE products.

Responsibility for environment and people

We at VILPE take concrete actions to support environmentally sustainable production. The largest green energy investment in our history has been replacing oil with geothermal heat. This reduces the CO2 emissions of the factory by 330 tons annually. We also design energy efficient products. Our goal is to increase the plastics recycling possibilities during the whole lifetime of the product. Environmental sustainability is also a part of our machine investments.

Another important aspect is promoting social responsibility. Yearly, we invest 0.3 % of our turnover to support local welfare, such as, education, sports and disadvantaged children.



VILPE/03-2021

> VILPE.COM

VILPE Oy
Kauppatie 9
FI-65610 Mustasaari FINLAND

Sales and technical support
Tel. +358 20 123 3222
sales@vilpe.com

VILPE®
Innovative and Easy